

USER MANUAL

Revision 4, Jan 2002

IMPORTANT: Read these instructions before installing, operating, or servicing this system

OXFORD *Voyager*

VOYAGER PORTABLE

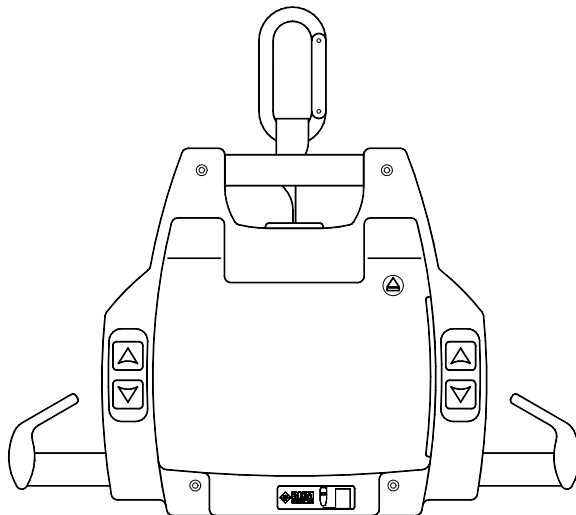

**1.1.1 DO NOT DESTROY
KEEP KEY ENCLOSED AND MANUAL WITH
THE LIFT AT ALL TIMES.**

IMPORTANT: Read these instructions before installing, operating or servicing this system.

INTRODUCTION

**This lift has been distributed by Sunrise Medical Ltd.
It is manufactured by BHM Medical Inc, Quebec, Canada.**

Please take the time to read the entire manual, including the section on Safety Instructions and Warnings. It contains important information that will allow you to take advantage of all the characteristics of your Voyager patient lift.

Suitability

The Voyager range of lifts are suitable for the following categories of lift within the working parameters of the lifts specified in the technical specifications:-

Category A – Wheelchair
Category B – Bed
Category C – Bath
Category D – Toilet/ shower chair
Category E – Floor
Category F – 90 degree rotation

The Voyager series are suitable for patients in the sitting, sitting/recumbent and recumbent positions.

Approvals

CSA 601.1
UL 2601.1
EN 60601.1
EN ISO 10535 (Lifting device) SGS
UK Test Report: DUR22107/AC/OO

Note: BHM Medical is constantly improving its products. For this reason, it may be possible to encounter a modification of product without revision of this guide.



Sunrise Medical Ltd
High St, Wollaston
Stourbridge
W. Midlands
DY8 4ZH
Tel +44 1384 446688
Fax +44 1384 446699
www.sunrisemedical.co.uk

BHM Medical Inc.
2001 Tanguay Street
Magog (Quebec)
Canada J1X 5Y5
Phone: +1 (819) 868-044
Fax +1(819) 868-2249
www.bhm-medical.com
email: bhm@bhm-medical.com

TABLE OF CONTENTS

INTRODUCTION.....	2
SUITABILITY	2
APPROVALS	2
1 INTRODUCTION.....	4
1.1 HOW TO USE THIS MANUAL	4
1.2 EQUIPMENT IDENTIFICATION	4
1.3 RECEIPT OF EQUIPMENT.....	4
1.4 KEY TO SYMBOLS	4
2 SAFETY INSTRUCTIONS AND WARNINGS.....	5
2.1 GENERAL	5
2.2 LIFTING WITH THE VOYAGER.....	5
2.3 SLING USAGE.....	6
2.4 FIRE AND EXPLOSION PREVENTION	6
2.5 PARTS AND ACCESSORIES	6
2.6 EQUIPMENT WARNING LABELS	6
3 DESCRIPTION OF EQUIPMENT	7
3.1 LIFT UNIT	7
3.2 WHAT'S INCLUDED.....	7
3.3 PARTS DESCRIPTION	7
3.4 DIMENSION	7
4 OPERATION	8
4.1 HOW TO USE THE VOYAGER PORTABLE	8
4.2 EMERGENCY LOWERING FEATURE.....	9
4.3 SLING USAGE.....	10
5 BATTERY INFORMATION.....	10
5.1 CHARGER SPECIFICATIONS #A8200	11
5.2 CHARGING THE BATTERY WITH CHARGER #A8200	11
5.3 CHARGER SPECIFICATIONS #700.13500.....	12
5.4 CHARGING THE BATTERY WITH CHARGER # 700.13500.....	12
6 MAINTENANCE	13
6.1 DAILY CHECK LIST	13
6.2 INSPECTION AND CLEANING	13
6.3 STRAP INSPECTION.....	13
6.4 HANDLING AND STORAGE.....	14
6.5 BATTERY REPLACEMENT	14
6.6 CHARGER FUSE REPLACEMENT (CHARGER #A8200 ONLY).....	14
6.7 SLING INSPECTION	15
6.8 ANNUAL INSPECTION	15
6.9 UK REGULATIONS	15
6.10 MAINTENANCE INSPECTION CHECKLIST	16
7 TROUBLESHOOTING	17
8 ACCESSORIES	19
9 LOG BOOK.....	20
10 WARRANTY.....	23

1 INTRODUCTION

1.1 How to use this Manual



DO NOT ATTEMPT TO USE THIS EQUIPMENT WITHOUT UNDERSTANDING THIS MANUAL.

To ensure safe operation, read the entire manual carefully, especially the section on “Safety Instructions and Warnings”, before installing, operating, or servicing this equipment.

If anything is not completely understood, please contact your supplier for more details. Failure to comply with warnings in this manual may result in injury.

Keep this manual with the lift and refer to it as required. Contents of this manual are subject to change without prior notice to users.

Throughout this manual, the following symbols may appear. Pay particular attention to the information provided under these headings. These special annotations are easily recognized as follows:



WARNING: this symbol is intended to alert the user to hazards or unsafe practices, which could result in serious bodily harm.



CAUTION: this symbol is intended to alert the user of the presence of important operating and maintenance instructions, which could prevent product damage or possible personal injury.



NOTE: this symbol offers helpful information concerning certain operating procedures.

Additional copies of this manual can be purchased by contacting your supplier. Include the User Manual product number and equipment identification numbers.

1.2 Equipment Identification

The unit's identification number (specification, model, serial number) appears on a silver nameplate attached to the back of base.

1.3 Receipt of Equipment

Upon receipt of the equipment, verify it against the packing list to ensure it is complete and inspect the equipment for possible damage due to shipping. If there is any damage, DO NOT USE the equipment and notify the carrier immediately to file a claim. Provide complete information concerning damage claims or shipping errors to your supplier. Include all equipment identification numbers and group part numbers (if any) as described above along with a full description of damaged parts.

1.4 Key to Symbols

THE FOLLOWING SYMBOLS ARE USED ON LIFTER'S ATTACHMENT LABELS:

CE This symbol is required to be displayed on regulated products for sale in the European Market. It indicates that the product complies with applicable European Directives related to health, safety, environment and consumer protection.

SWL Safe Working Load represents the maximum load the lifter is rated for safe operation.

The following symbols are used on sling labels and related to washing instructions:

 Maximum washing temperature 71°C (140°F) permanent cycle.

 Do not use bleach.

 Do not dry clean.

 Tumble dry low temperature.

 Do not iron.

Please refer to individual sling labels for complete instructions regarding washing and drying.

2 SAFETY INSTRUCTIONS AND WARNINGS

IMPORTANT – READ AND UNDERSTAND THESE INSTRUCTIONS. DO NOT LOSE THEM. ALSO READ OPERATING/ INSTRUCTION CHAPTER OF THIS MANUAL BEFORE INSTALLING, OPERATING OR SERVICING THIS EQUIPMENT

2.1 GENERAL

- **IMPORTANT – READ THESE INSTRUCTIONS CAREFULLY OR SERIOUS INJURY MAY RESULT.**
- **KEEP THESE INSTRUCTIONS AND THE KEY PROVIDED WITH THE LIFT AT ALL TIMES.**
- **READ OPERATION AND MAINTENANCE INSTRUCTIONS IN THIS MANUAL BEFORE INSTALLING, OPERATING, OR SERVICING THIS EQUIPMENT.**
- **An authorized contractor or installer must install Voyager ceiling lifts.**
- **USE all controls and safety features only according to the rules specified in this manual. Never attempt to force a control or button on the lift.**
- **DO NOT store the charger in a shower, bath or other areas with high humidity.**
- **DO NOT drop the patient lift or battery. Dropping the battery or lift may cause internal damage that is not easily seen. If lift is suspected to be damaged, take to an authorized technician for servicing.**
- **IMPORTANT: Keep all components of the lift clean and dry, and have electrical and mechanical safety checkpoints done as instructed in the Maintenance section of this manual.**
- **Replace any precautionary or instruction labels that cannot be easily read.**
- **Avoid violent shock during transportation.**

2.2 LIFTING WITH THE VOYAGER

- **YOUR LIFT is for transferring patients only. Do not use the lift for any other purpose.**
- **ALWAYS carry out the daily checklist before using the lift.**
- **Voyager ceiling lifts are intended to be used for patients within the specified weight limit indicated for the lift. Do not attempt to lift more than the weight limit indicated.**
- **Before attempting to transfer, the patient must be assessed by a qualified professional.**
- **Voyager ceiling lifts must be used by a caregiver with proper training to work with the patient to be transferred.**
- **ONLY trained and qualified caregivers should transfer a patient. DO NOT attempt to use the lift if you have not been properly trained to do so.**
- **ALWAYS be prepared before attempting to transfer a patient.**
- **FOLLOW lifting procedures outlined in this manual.**

2.3 SLING USAGE

- **ONLY** use Sunrise slings that are designed to fit with the Voyager
- **ALWAYS** refer to the Sling User Manual for instruction on fitting, care and maintenance
- **DO NOT** use a sling that is not recommended for the lift.
- **NEVER** use a damaged, torn or frayed sling.
- **ALWAYS** place the sling around the patient according to the instructions enclosed.
- Voyager ceiling lifts are specifically designed for Sunrise Voyager ceiling rail systems, slings and accessories. Slings and accessories designed by any other manufacturer are prohibited and will void the Voyager warranty. Use only Sunrise Medical slings and accessories to maintain patient safety and product utility.
- **DO NOT** use other manufacturer's slings.
- **DO NOT** use Sunrise slings on other manufacturer's hoists.
-

2.4 FIRE AND EXPLOSION PREVENTION

- Batteries may explode, leak and cause personal injury if not disposed of properly.
 - Do not place or store the battery under direct sunlight or near a heat source
 - Do not dispose of in fire
 - Do not short the battery terminals
 - Do not incinerate
 - Flush with water if electrolyte (Acid) comes in contact with skin or eyes.
- Batteries must be recycled, disposed of according to local law regulations. When returning batteries, insulate their terminals with adhesive tape, etc. Otherwise, the residual electricity in used batteries may cause fire or explosion.



2.5 PARTS AND ACCESSORIES

- Always use VOYAGER replacement parts and accessories. Using other parts and accessories other than recommended by BHM/ SUNRISE could affect security and efficiency of the entire system. SUNRISE VOYAGER slings and patient lift accessories are specifically designed to be used in conjunction with BHM patient transfer aids. Sling and accessories designed by other manufactures are not to be used as a component of VOYAGER patient transfer systems.

2.6 EQUIPMENT WARNING LABELS

- **INSPECT** all precautionary labels on the equipment. Order and replace all labels that cannot be easily read.

3 DESCRIPTION OF EQUIPMENT

3.1 Lift Unit

The lift unit is an aluminium frame based system driven by a gear reduced high torque motor.

OPERATING FEATURES

- Ultra-light; 5.45 kg (12 pounds.) battery included.
- Electronic soft-start and soft-stop motor control.
- Easily accessible controls on both sides of the unit.
- Manual emergency lowering device (in case of electrical failure).
- Emergency brake (in case of mechanical failure). Operates on the same principle as a car safety belt mechanism.
- *Quick-Release* feature allows very fast winding and unwinding of the strap before and after transfer operation.
- *Anti-crush* feature stops the lift when there is no tension on the strap, avoiding any injury to the patient. This feature also prevents the strap from getting twisted inside the machine.
- Current limiter for circuit protection in case of overload.
- Low battery disconnect system to protect batteries from been drained.
- Lifting speed: 4 cm/sec. (1.6 in./sec.).
- Strap length up to 2.2 m (88 inches). Tested for 1363.6 kg (3000 lbs.).
- CSA No. 601.1, UL No. 2601-1 and CE certifications.
- Respects EMI standards.

3.2 What's included

ITEM	QTY
Voyager lift	1
Battery	1
Charger	1
Power cord	1
4 mm Allen key	1
Instruction manual	1

3.3 Parts Description

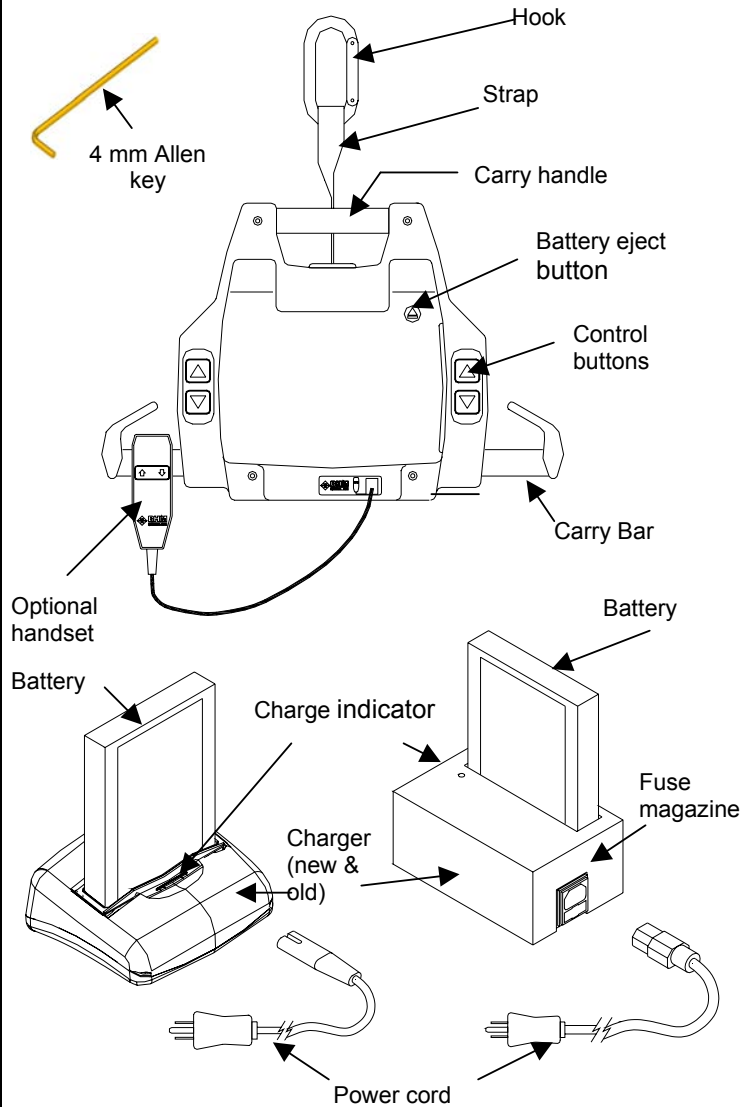

3.4 Dimension

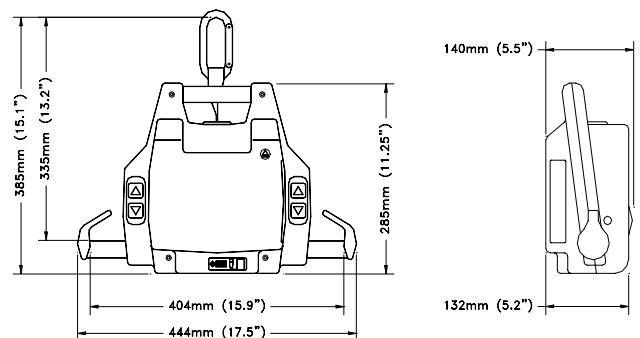

4 OPERATION

4.1 How to use the Voyager Portable



READ "SAFETY INSTRUCTIONS AND WARNINGS" BEFORE ATTEMPTING TO USE THE VOYAGER LIFT.

Always carry out the daily checklist before each lift use.



Damage to the lift may occur if not properly handled. Carry the VOYAGER PORTABLE by its handle only. Do not carry the lift with the reacher accessory or other accessory not intended to be used to carry the lift.

1. Install the patient sling (see sling installation)
2. Take the battery out of the charger and insert it into the lift. Make sure the silver contact points go inside the lift.

Once the patient sling is installed, unwind the strap. There are two ways to unwind the strap:

First, you can press the  button while holding tension on the strap with the other hand (there must be tension on the strap for the lift to function).

The other way to do this is to use the "QUICK-RELEASE"; Push the knob (1) and pull the strap out of the lift (2).

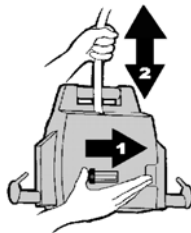

Push knob completely over to ensure the QUICK-RELEASE will work properly.



QUICK-RELEASE will not work if there is tension on the strap. Make sure the strap has some slack in it before attempting to slide the knob over.

DO NOT force the knob. It should slide easily.

3. Attach the round hook to the trolley in the track.



To help you reach the trolley, use the arm extension as follows:

Insert the round hook into the loop of the arm extension #A8300 (1), then hook it to the trolley in the track (2).

(1)

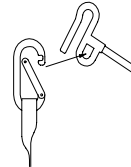

(2)

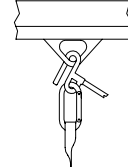

4. Move the lift over to the patient.



Hold the lift with one hand at all times when near a patient.

5. Lower the lift below the chin before beginning to attach the sling straps (this is to avoid the risk of facial contact caused by movement of the lift).

For a patient in a lying position, lower the lift near the thorax, and then install the straps.

6. Attach the straps of the sling as described in the sling attachment instructions for the sling to be used. (See sling installation)
7. Lift the patient slightly by pressing the control button 





BEFORE LIFTING THE PATIENT:

1. Make sure that all straps are attached to the carry bar.
2. Make sure the patient's arms are safely out of the way.
3. Make sure the sling is not caught on an obstruction (wheelchair brake or arm of chair).

If any of the above occur – lower the patient immediately and correct the problem.

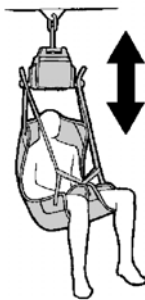
8. Lift until the patient's buttock clears the arm supports or the top of the bath or bed before moving the patient. Guide the legs past any obstacle.



9. When the patient is located above the desired point of transfer and ready to be lowered, press the  button.

10. Use the handles on the back of the sling to position the patient when transferring into a chair. Hold the handles firmly as the sling lowers and the sling will tilt back to position the patient.

11. Once the patient is properly seated and the straps are loose, remove the sling from the lift.

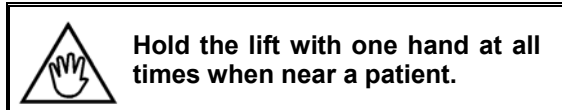

12. Slide the lift away from the patient.

13. Unhook the lift from the trolley in the rail and use the "QUICK RELEASE" to shorten the strap. To do so, push the knob (1) and hold the strap while it winds itself into the lift.

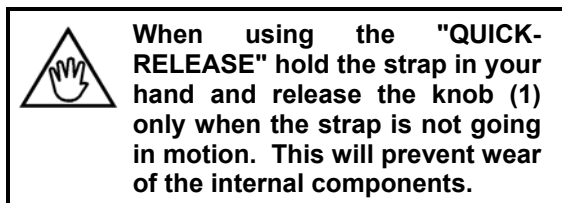
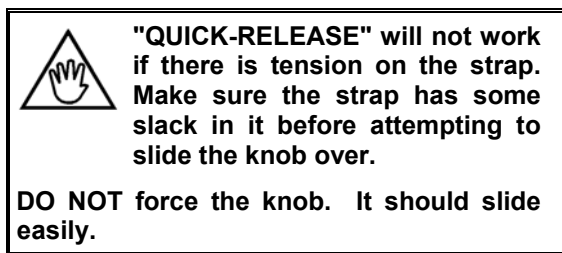
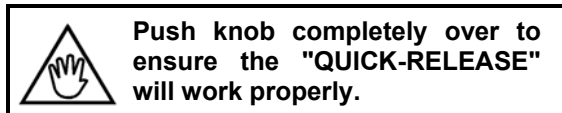
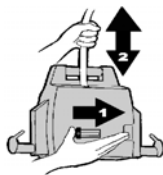

15. Sling may be removed from around the patient.

4.2 Emergency Lowering Feature

The Voyager Portable has an emergency manual-lowering feature in the event of an electrical or functional failure.

If the lift malfunctions when a patient is being transferred, the emergency manual lowering device provides a safe way of lowering the patient onto a chair or bed.

To operate the emergency lowering feature:

1. Find the rubber stopper and label on the side of the lift.

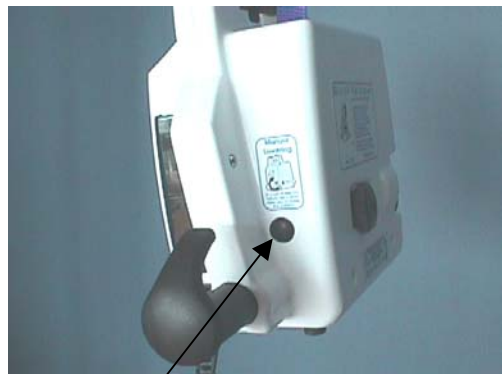

2. Pull the rubber stopper out of the Voyager Portable casing – DO NOT DISCARD.
3. Move the patient over a bed or chair.
4. Using the Allen key provided with this manual, turn the key clockwise to lower the patient into the chair. As the key turns the motor directly, each key turn will move the patient slightly.



To lower the patient more quickly, use a power drill with a 4 mm Allen key bit.



- Once the patient is lowered safely into a chair or bed, take the lift to a certified technician to be serviced.

4.3 Sling Usage

- See separate Sling Manual for sling usage.
- Only use Sunrise (Oxford in UK) slings.
- Only use slings as per the manufacturer's guidelines.
- Inspect and maintain slings as per manufacturer's guidelines.
-

5 Battery Information



DO NOT DROP BATTERY. A DROPPED BATTERY MAY HAVE INTERNAL DAMAGE THAT IS NOT VISIBLE. IT MAY LOSE ITS ABILITY TO RECHARGE.

Due to internal damage caused when the battery is dropped, the battery may indicate that it is fully charged, when in fact the battery cannot hold a full charge. A green light indicated on the charger may not accurately reflect a full charge on a damaged battery.

NEVER attempt to use a battery that appears to be damaged or dented.

DO NOT store battery near a heat source. Heat will damage the battery.

Always keep metal battery contacts clean.

- 24 Vdc, 2.0 Ah interchangeable and rechargeable battery.
- Provides 10 to 30 transfers per battery charge (may vary depending on patient weight and battery condition. See graph below).

Life cycle (number of charging cycles) of the battery is largely dependent on the depth of discharge in each cycle. The more the battery is drained, the shorter its life span. The life of the

battery is also related to such factors as varying temperatures and rest periods between charge and discharge.

Graph 1: Number of recharge vs. Depth of discharge

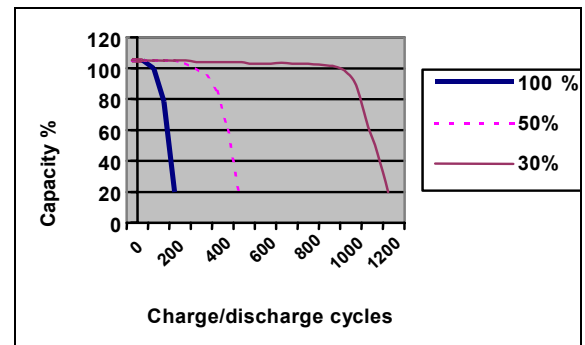

GRAPH #1 illustrates the relationship between discharging depth and expected battery life.

If you use only 30% of the battery power between each charge, you can expect the battery to fully charge 1050 times.

If you drain the battery until it beeps every time, you can expect the battery to fully charge only 300 times.



To prolong battery life - Put the battery into the charger WHENEVER THE LIFT IS NOT IN USE.

The battery will not overcharge.

BHM uses sealed lead-acid batteries. Contrary to nickel-cadmium, BHM batteries do not have any memory effect. Therefore, batteries should not be completely drained before recharge.

Graph 2: Number of lifts vs. Lift load

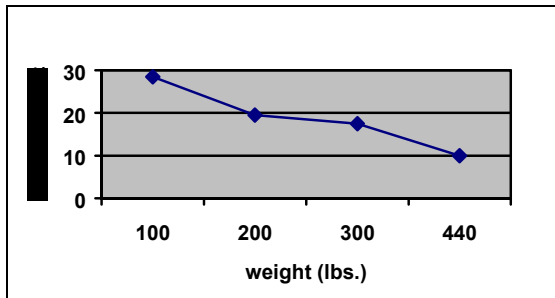

The graph above (GRAPH #2) illustrates the relationship between the load lifted and the number of lifts that can be done with one recharged battery.



Do not drain the battery excessively. This will dramatically reduce the battery life span.

If the low battery buzzer sounds, be sure to recharge the battery as soon as possible.

5.1 Charger Specifications #A8200

- Hospital grade charger cord and plug.
- Charger input: 120 Vac, 60 Hz, 0.5 A. (North America)/ 240 Vac, 50 Hz, 0.25 A European.

5.2 Charging the Battery with Charger #A8200



DO NOT OPERATE THE CHARGER UNIT WITH A DAMAGED CORD OR IF THE UNIT HAS BEEN DROPPED OR DAMAGED.

DO NOT forcibly bend the power cord or place a heavy object on it. This will damage the cord and may cause fire or electrical shock.

DO NOT pour liquid on or near the charger.



DO NOT place the unit in locations that are:

- Extremely hot
- Dusty or dirty
- Very humid
- Moving or vibrating

Do not attempt to put a damaged battery into a charger. Inspect the battery first for dents or damage.

The recharging steps should be as follows:
(See step by step instructions)

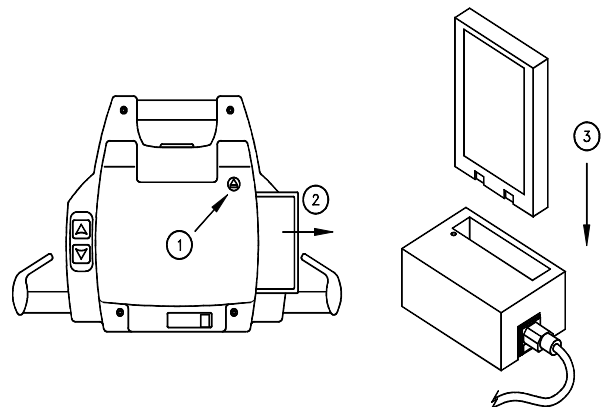

- Eject the battery from the lift unit by using the "Battery Eject Button" (1). Keep your hand near the opening to catch the battery (2).



Keep one hand near the opening for the battery (2) before pushing eject button. Do not allow the battery to eject and fall.

- Insert the battery into the charger (3) with the silver contact points of the battery going into the charger.
- The charging indicator light will illuminate red to white to green depending on the battery drain. If the light does not go on, check the "Troubleshooting" section in this manual for assistance.
- If the battery is low, the light will show red or orange when you place the battery in the charger. The light will gradually turn to a white or yellow color, then to green when fully charged.





Whenever possible, leave the battery in the charger when the lift is not in use.



At minimum, charge the battery until the light is green before using again. This will extend the life of the battery.

- When the lift is needed again, pull the battery out of the charger, and gently slide it back into the Voyager Portable lift. The silver contacts should be inside the lift.
- The power cord can remain plugged into the wall indefinitely, convenient for overnight recharging.

- If the battery has been in the charger for an Insert the battery into the charger with the silver contact points of the battery going into the charger.
- The charging indicator light will flash yellow while the battery is charging. If the battery is approximately within 85% of being fully charged, the charging indicator light will illuminate solid yellow.
- If the battery is low, it will take approximately 2 hours for a full charge.

	Whenever possible, leave the battery in the charger when the lift is not in use.
	At minimum, charge the battery until the light is solid yellow (not flashing) before using again. This will extend the life of the battery.

- When the lift is needed again, pull the battery out of the charger and, gently slide it back into the Voyager portable lift. The silver contacts should be inside the lift.
- The power cord can remain plugged into the wall indefinitely, convenient for overnight recharging.
- The battery can be left in the charger for an extended period of time without damaging either the charger or battery.
- If the green light does not go on when the charger is plugged into an electrical outlet, see "Troubleshooting" extended period of time or if the battery has not been drained: it is possible that the light on the charger will turn off, or will not go on. This is only the case when the battery is 99.9% charged.
- To test the charger, use the battery in the lift a few times then put the battery in the charger. If the light still does not go on, see the "Troubleshooting" section.

5.3 Charger Specifications 700.13500 (new version)

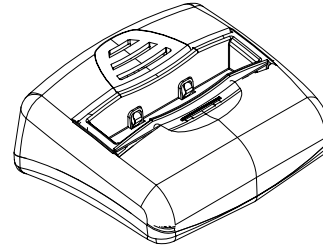

- Class 2 power cord rated at 2.5 A (100-240 Vac 50-60 Hz).
- Charger input: 100-240 Vac, 50-60 Hz, 50VA
- Charger output 27 Vdc 1A.
- Input fuse – 1A 250 V located inside the charger.

Green light showing power to the charger

Solid yellow light showing battery 85% charge
Yellow light blinking showing battery under charge

INPUT = 100 - 240 V~, 50/60 Hz, 50VA
OUTPUT = 27 V ---, 1.0 A

LR 101445 C SP US

CE □ ! SN- _____

ITEM : # 700.13500 MFG DATE /200

MANUFACTURED BY BHM MEDICAL INC. MADE IN CANADA

5.4 Charging the Battery with Charger # 700.13500

(Available Oct. 2001)
Check to make sure the green light on the charger is illuminated. This indicates that the charger is on.

6 MAINTENANCE



ALWAYS CARRY OUT THE DAILY CHECKLIST BEFORE EACH LIFT USE.

DO NOT attempt to open the VOYAGER PORTABLE. Only a certified technician is authorized to open the VOYAGER PORTABLE.

Alterations made to the VOYAGER PORTABLE by someone other than a certified technician may cause serious injury.

VOYAGER PORTABLE and accessories must be inspected ANNUALLY by a certified technician in addition to the daily and other periodic visual checks done by the user specified in this section.

Preventive maintenance specified in this manual can prevent accidents and reduce repair costs.

Note all service or repairs to the VOYAGER or its accessories in the log book at the end of this manual. Have the document signed by a certified technician

6.1 Daily Check List

THE FOLLOWING PROCEDURE MUST BE FOLLOWED BEFORE EACH USE.

- Has the battery been charged? Charge the battery whenever the lift is not in use.
- Inspect the battery before placing it in the Voyager portable. If the battery appears to have any damage – DO NOT USE IT. Replace the battery immediately (Product # A8500)
- Inspect the lift for any damage. If the lift casing does not look properly aligned, or there are any cracks or other damage on the lift, or any parts are missing - DO NOT USE IT. Contact your local representative to have the lift serviced.
- Attach the lift to the trolley in the rail. Inspect the visible strap for any signs of wear, frays, loose threads or other damage. If there is any evidence of damage- DO NOT USE IT. Contact your local representative to have the lift serviced.
- Inspect the sling for tears, frayed straps or loose stitching. If the sling has any of the

above damage –DO NOT USE IT. Contact your local representative to have the sling replaced or repaired.

- Inspect the reacher and adjustable extension strap (if you have these options) for wear. Check the adjustable extension strap for frays or loose stitching. Check the reacher for damage in the metal hook or handle. DO NOT USE if there is any damage.
- Inspect the hook at the top of the strap to ensure it is properly attached and there is no damage to the hook.

6.2 Inspection and Cleaning

Clean the voyager body with a dry soft cloth, or a soft cloth lightly moistened with a mild detergent solution. Do not use any type of solvent that may damage the finish.



DO NOT immerse lift in water.

To ensure a better rolling surface for the trolley wheels, clean the inside of the track every 4 months. To do so, insert a damp cloth in the opening and slide it from one end of the track to the other.



Always replace rail end stopper (if they have been removed) after servicing.

6.3 Strap Inspection

This equipment is built with a strap that can withstand a load of 1364 kg (3000 lbs.) Nonetheless, if this strap is damaged or shows signs of wear, the acceptable load on the strap before rupture can drop rapidly and present a danger for the patient or caregiver.

BHM Medical recommends thoroughly inspecting the strap every 2 months as follows:

1. Completely unwind the strap.
2. Look for any signs of wear.

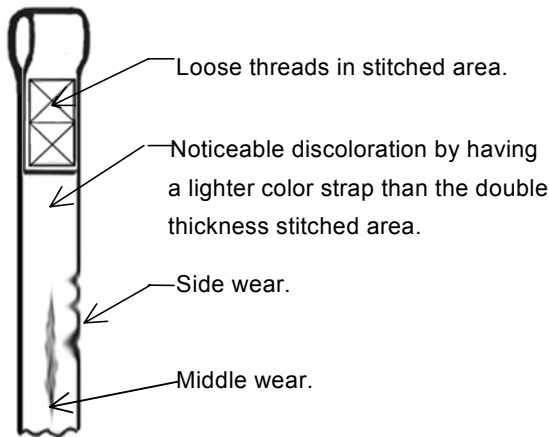

 If there are any signs of wear as indicated here or other visual defects, strap should be changed immediately. By continuing to use the lift without changing the strap, caregiver and patient safety is greatly compromised.

In any case, manufacturer recommends to change strap at least every two years. By continuing to use the lift without changing the strap, caregiver and patient safety is greatly compromised.

Take note of results of inspection in the log book at the end of this manual.

6.4 Handling and Storage

Avoid violent shock during transportation.

The lift should not remain stored for long periods of time without recharging the batteries.

 **BHM Medical recommends charging of batteries at least every two weeks even if the lift is not used. This will prevent premature aging of batteries.**

6.5 Battery Replacement

BHM uses sealed lead-acid batteries. Contrary to nickel-cadmium, BHM batteries do not have

any memory effect. Therefore, batteries should not be completely drained before recharge.

Replace the battery when it has been dropped or if there is a noticeable reduction in the number of transfers that can be performed between charges. If you notice the Voyager Portable “beeping” – see the instructions in “Troubleshooting” section to ensure it is a problem with the battery.

To replace a battery, contact your local dealer or representative and order product # A8500.

 **DO NOT ATTEMPT TO USE A BATTERY NOT AUTHORIZED BY BHM MEDICAL.**

 **BHM batteries are specially designed for BHM charging systems. Attempting to use an unauthorized battery may seriously damage the lift and/or the charger.**

6.6 Charger Fuse Replacement

(Charger #A8200 only)

If the charger light does not illuminate when there is a battery in it, do the following steps:

1. Make sure the battery is properly placed in the charger. The silver contact points should be inside the charger.
2. Check to make sure the power cord is correctly plugged in to the charger and the wall.
3. If the light still doesn't work, plug the charger into a different outlet in a different area to ensure that the outlet is working properly.
4. Pull the power cord out of the charger. Under the socket on the charger, there is a drawer or magazine where there is a fuse. Using a pen or screwdriver, pull the drawer out gently. Pull the burnt fuse out of the drawer that is next to the charger (see diagram below) and discard. Take the replacement fuse and place it in the same slot where the burnt fuse was. Slide the drawer back into the charger. Plug the power cord into the charger. Place the battery into the charger and check for the light.
5. If the light does not illuminate, contact your local dealer or representative for assistance.

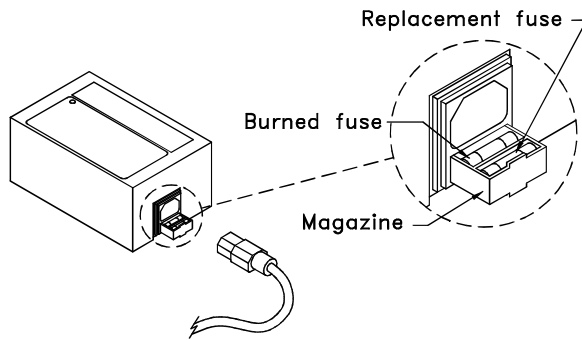

Replace the fuse with the following:

Fuse: GMC 0.5 A 250 V North America (When input is 120 Vac) Product # C8FGMC0.5

GMC 0.25 A 250 V European (When input is 240 Vac) Product # C8FGMC0.250

The fuse may also be ordered through your local dealer or representative.

6.7 Sling Inspection

- Confirm the sling is a Sunrise Medical sling.
- Check the load bearing straps for wear or fraying
- Check the sling straps are securely stitched
- Check the body of the sling for wear, cuts in the fabric.
- Check any sling accessories (ie additional spreader bars / side suspenders) for wear on the hooks or central suspension point.

6.8 Annual Inspection

The Voyager Portable and its accessories must be inspected annually by a certified technician.



VOYAGER PORTABLE AND ACCESSORIES MUST BE SERVICED EVERY 12 MONTHS AS A MINIMUM REQUIREMENT. IN THE UK THE VOYAGER PORTABLE MUST BE INSPECTED AND MAINTAINED IN COMPLIANCE WITH 1998 No 2307 HEALTH & SAFETY: LIFTING OPERATIONS AND LIFTING EQUIPMENT REGULATIONS 1998.

Do not attempt to do the inspection unless you are certified to do so.

As part of the annual inspection, an annual load test with the safe working load must be performed on the VOYAGER PORTABLE as required for CE MARK MAINTENANCE.

After annual inspection, have the log book signed by the certified technician.

6.9 UK Regulations

IN THE UK THE VOYAGER PORTABLE MUST BE INSPECTED AND MAINTAINED IN COMPLIANCE WITH 1998 NO 2307 HEALTH & SAFETY: LIFTING OPERATIONS AND LIFTING EQUIPMENT REGULATIONS 1998. YOUR DEALER WILL PROVIDE YOU WITH MORE INFORMATION

MAINTENANCE CHECKLIST

6.10 Maintenance Inspection Checklist





TO BE INSPECTED BY USER						
ITEM	INITIALLY	BEFORE EVERY USE	EVERY 2 MONTHS	EVERY 6 MONTHS	EVERY YEAR	EVERY 2 YEARS
LIFT DEVICE						
Inspect for missing hardware or broken panel.	X	X			X	
Inspect strap for wear.		X	X			
Battery recharge.		X				
Inspect round hook on the strap of the lift for damage or cracks.					X	
Inspect trolley in rail for damage, rust or cracks. Replace if damaged.					X	
Overall inspection by authorized personnel					X	
SLING AND HARDWARE						
Check all sling attachments for sign of wear.		X				
Inspect sling material for wear or deterioration.		X				
Inspect sling straps for wear.		X				
Inspect for any defect or loose threads in the "stitched areas".		X				
Cleaning sling as indicated on the tag.	<i>When Necessary</i>					
ACCESSORIES						
Verify strap extension for wear				X		
Verify arm extension for wear				X		
MAINTENANCE BY A CERTIFIED TECHNICIAN						
Replace strap.						X
Inspect the welding aspect on the frame to detect cracks.					X	
Inspect connecting joints for proper attachment.					X	
Verify that the emergency brake on the drum is turning freely.					X	
Verify emergency devices for good functioning.					X	



Maintenance inspection points are suggested by the manufacturer, however in certain cases, some inspections should be done on a more frequent basis. By continuing to use the lift without replacing the listed parts in this maintenance inspection checklist, caregiver and patient safety is greatly compromised.

7 TROUBLESHOOTING

	<p>DO NOT attempt to open the VOYAGER PORTABLE. Only a certified technician is authorized to open the VOYAGER PORTABLE. Alterations made to the VOYAGER PORTABLE by someone other than a certified technician may cause serious injury.</p>
---	--

PROBLEMS	TO CHECK
<p>The unit does not work when you press the  or  buttons on the handset.</p>	<ul style="list-style-type: none"> • Make sure the handset is plugged correctly into the unit. • Use the control switches directly on the unit. If they are working, it indicates a problem with the handset; you would then need to change the handset.
<p>The unit does not work when you press the  or  buttons on both sides of the lift.</p>	<ul style="list-style-type: none"> • Is the battery charged and correctly installed? Ensure the battery is inserted into the lift with the silver contact points inside the lift. Place the battery into the charger and check the light on the charger. If the light remains red, leave the battery in the charger for approximately 2 hours. • Is the “QUICK RELEASE” knob completely to the left (locked) position? If not, the lift will not operate. Tighten the tension on the strap to help move the “Quick Release” knob. • Is there tension on the strap? The “Anti Crush” feature will prevent the lift from working if there is no tension. • If all of the previous points have been checked without success, you probably have a motor or electric problem, you then need to call your BHM Medical representative.
<p>The unit starts and stops repetitively.</p>	<ul style="list-style-type: none"> • If the load is more than safe working load, the unit will not work due to an overload protection on the motor. • Has the lift been making a “beeping” sound? The battery is low and needs to be charged.
<p>The lift emits a “beep” during utilization. The unit may stop lifting but you can still lower it.</p>	<ul style="list-style-type: none"> • Batteries are low, recharge them
<p>Charge indicator on the charger #A8200 (green-red) does not light up when the battery is in the charger</p>	<ul style="list-style-type: none"> • Check the orientation of the battery. The silver contact points should be inside the charger. • Is the charger plugged into a standard outlet? • Check the condition of the fuse. If needed, change it with a spare one. (see “Maintenance” section of this manual) • Has the battery been in the charger for many hours? See “Battery Information” and “Charging the Battery “ in “Maintenance” section.
<p>The light on the charger #A8200 shows green when the battery is inserted; yet the lift will only work when there is no one in the lift. When you attempt to transfer someone, the lift stops.</p>	<ul style="list-style-type: none"> • Battery is damaged – have it replaced.
<p>The light on the charger #A8200 always lights up red – does not turn to green after an overnight charge.</p>	<ul style="list-style-type: none"> • Try a different battery in the charger if available. • Take the battery and charger to a certified technician.

TROUBLESHOOTING

PROBLEMS	TO CHECK
Battery is always dead after a few transfers (3 to 5).	<ul style="list-style-type: none"> • Replace battery with a new one, the life of the current one is probably nearly over. (See the "Battery Information" section on page 20)
The light on the charger shows green (yellow for charger #700.13500) when the battery is inserted, yet the lift will only do one or two transfers.	<ul style="list-style-type: none"> • Battery has either been dropped or damaged in some other way. Replace the battery.
Charger #700.13500: Green light is not illuminated	<ul style="list-style-type: none"> • Is the charger plugged into a standard outlet? • Try plugging the charger into another outlet to see if it will work. • Contact your local dealer or representative.
Charger #700.13500: When battery is inserted into the charger, the yellow light does not flash or illuminate solid.	<ul style="list-style-type: none"> • Check the orientation of the battery. The silver contact points should be inside the charger. • Contact your local dealer or representative.
The battery does not slide into the lift.	<ul style="list-style-type: none"> • Check if there is any damage to the battery that would interfere in the lift battery's slot. IF THERE IS DAMAGE - DO NOT USE THE BATTERY. • Try to slide in another battery to see if there is any damage in the lift battery's slot. If so, call your BHM Medical representative, if not discard the damaged battery.
Cannot remove battery from the lift.	<ul style="list-style-type: none"> • See "Operation" instructions "Charging the Battery" on how to remove the battery. • If the battery will not come out of the lift, tilt the lift to the side so that the battery opening is under the lift. With your hand guarding the opening for the battery, press the eject button on the front of the Voyager Portable while gently tapping the lift to help jolt the battery out of the lift. ONCE THE BATTERY IS REMOVED – DISCARD BATTERY AND REPLACE. • If you cannot remove the battery after trying the above, contact your local dealer or representative for assistance.

8 ACCESSORIES

BATTERY
Product No. A8500

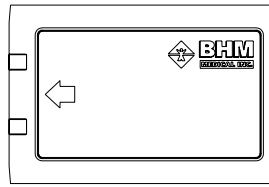

HOOK
Product No. Q8000

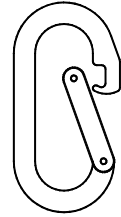

CHARGERS
Product No. A8200

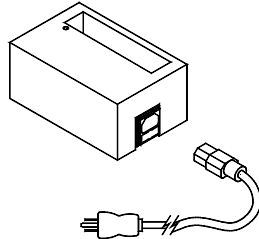

STANDARD TROLLEY
Product No. A5900

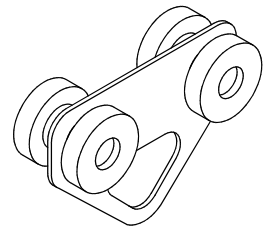

Product No 700.13500

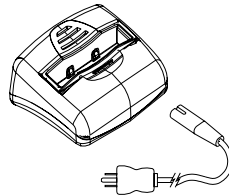

SWIVEL TROLLEY
Product No. A5910

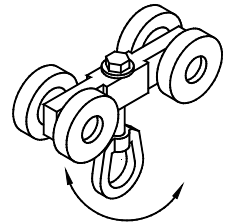

FUSE
Product No.
C8FGMC0.5 (120/24 volt) North America
C8FGMC0.25 (240/24 volt) European

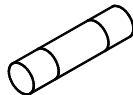

ARM EXTENSION
Product No. A8300

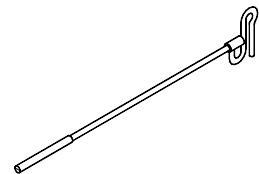

HANDSET
Product No. 700.13600

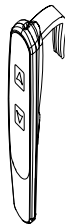

ADJUSTABLE STRAP EXTENSION
Product No. A3710

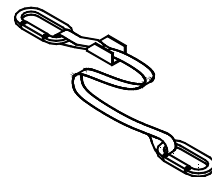

LOG BOOK

Service Type <input type="checkbox"/> Pre-delivery <input type="checkbox"/> Periodic inspection <input type="checkbox"/> Minor <input type="checkbox"/> Major	
Condition report : _____	
Action taken : _____	
Date : _____	Inspected by: _____ Printed _____ Signature

Service Type <input type="checkbox"/> Pre-delivery <input type="checkbox"/> Periodic inspection <input type="checkbox"/> Minor <input type="checkbox"/> Major	
Condition report : _____	
Action taken : _____	
Date : _____	Inspected by: _____ Printed _____ Signature

Service Type <input type="checkbox"/> Pre-delivery <input type="checkbox"/> Periodic inspection <input type="checkbox"/> Minor <input type="checkbox"/> Major	
Condition report : _____	
Action taken : _____	
Date : _____	Inspected by: _____ Printed _____ Signature

Service Type <input type="checkbox"/> Pre-delivery <input type="checkbox"/> Periodic inspection <input type="checkbox"/> Minor <input type="checkbox"/> Major	
Condition report : _____	
Action taken : _____	
Date : _____	Inspected by: _____ Printed _____ Signature

10 WARRANTY

This warranty is extended only to the original purchaser/user of BHM products.

BHM Medical Inc. warrants its products to be free from defects in material under normal use and service, within the periods stated below from the date of purchase. If within such warranty period any such product shall be proven to be defective, such product shall be repaired or replaced at BHM Medical's option. This warranty does not include any labor or shipping charges incurred in replacement part installation or repair of any such product. BHM Medical's sole obligation and your exclusive remedy under this warranty shall be limited to such repair and/or replacement.

Patient Lifter including/Hydraulics	1 year
Weighing Devices	1 year
Accessories on Lifter	1 year
Slings	1 year
Batteries - Voyager Portable	3 months
Batteries - All other lifts	1 year
Easytrack System	1 year

For warranty service, please contact the dealer from whom you purchased the BHM Medical product. [In the event that you do not receive satisfactory warranty service, please contact BHM Medical (see contact information in Table of Contents).]

Do not return products to our factory without prior authorization. BHM Medical will issue a Return Merchandise Authorization (RMA) Number. C.O.D. shipments will be refused; all shipments to BHM Medical must be prepaid. For this warranty to be valid, the purchaser must present its original proof of purchase at the moment of the claim. The defective unit, assembly or part must be returned to BHM Medical for inspection. The part or components repaired or replaced are guaranteed for the remaining period of the initial warranty.

Limitations and Exclusions:

The warranty above does not apply to serial numbered products if the serial number has been removed or defaced.

No warranty claim shall apply where the product or any other part thereof has been altered, varied, modified, or damaged; either accidentally or through improper or negligent use and storage. Warranty does not apply to products modified without BHM Medical's express written consent, (including but not limited to products modified with unauthorized parts or attachments), to products damaged by reason of repairs made to any component without the specific consent of BHM Medical, or to products damaged by circumstances beyond BHM Medical's control. BHM Medical will solely determine evaluation of warranty claim. The warranty does not apply to problems arising from normal wear or failure to adhere to the instructions in this manual. BHM Medical Inc. slings are void of warranty if not laundered as per instructions on the Sling Label.

BHM Medical Inc. shall not be liable for damages losses or inconveniences caused by a carrier.

This warranty replaces any other warranty expressed or implicit and constitutes BHM Medical Inc. only obligation towards the purchaser. BHM Medical shall not be liable for any consequential or incidental damages whatsoever.